

SPECIFICATION FOR APPROVAL

COMMODITY: *3mm Round Standard T-1 Type Ultra Red LED*

DEVICE NUMBER: DL-302SRCA-2SR20

CUSTOMER APPROVEDBY	DATE

Double Light

◆ **Features:**

1. Popular Standard T-1 diameter package.
2. High efficiency.
3. Selected minimum intensities.
4. General purpose leads.
5. Available on tape and reel.
6. Reliable and robust.
7. The product itself will remain within RoHS compliant version.

◆ **Descriptions:**

1. The series is specially designed for applications requiring higher brightness.
2. The LED lamps are available with different colors, intensities.

◆ **Applications:**

1. Status indicators.
2. Commercial use.
3. Advertising Signs.
4. Back lighting.

Double Light

◆ Package dimensions:

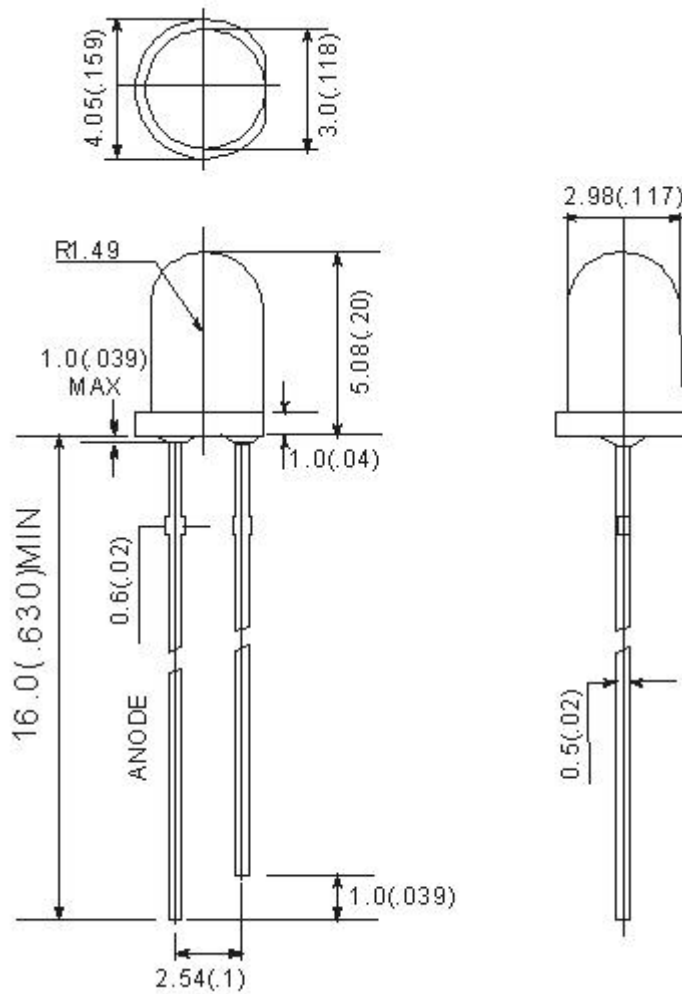

Part No.	Chip Material	Lens Color	Source Color
DL-302SRCA-2SR20	AlGaInP	Water clear	Ultra Red

Notes:

1. All dimensions are in millimeters (inches).
2. Tolerance is ± 0.25 mm (0.01") unless otherwise specified.
3. Lead spacing is measured where the leads emerge from the package.
4. Specifications are subject to change without notice.

◆ Absolute Maximum Ratings at Ta=25°C

Parameter	MAX.	Unit
Power Dissipation	65	mW
Peak Forward Current (1/10 Duty Cycle, 0.1ms Pulse Width)	100	mA
Continuous Forward Current	25	mA
Derating Linear From 50°C	0.4	mA/°C
Reverse Voltage	5	V
Operating Temperature Range	-40°C to +85°C	
Storage Temperature Range	-40°C to +105°C	
Lead Soldering Temperature [4mm(.157") From Body]	260°C for 5 Seconds	

Electrical Optical Characteristics at Ta=25°C

Parameters	Symbol	Min.	Typ.	Max.	Unit	Test Condition
Luminous Intensity *	IV	2500	3500	---	mcd	IF=20mA (Note 1)
Viewing Angle *	$2\theta_{1/2}$	---	20	---	Deg	IF=20mA (Note 2)
Peak Emission Wavelength	λ_p	---	632	---	nm	IF=20mA
Dominant Wavelength	λ_d	---	624	---	nm	IF=20mA (Note 3)
Spectral Line Half-Width	$\Delta\lambda$	---	20	---	nm	IF=20mA
Forward Voltage	VF	1.80	2.20	2.80	V	IF=20mA
Reverse Current	IR	---	---	10	μ A	VR=5V

Notes:

1. Luminous (Radiant) Intensity Measurement allowance is $\pm 10\%$.
2. $\theta_{1/2}$ is the off-axis angle at which the luminous intensity is half the axial luminous intensity.
3. The dominant wavelength (λ_p) is derived from the CIE chromaticity diagram and represents the single wavelength which defines the color of the device.

◆ Typical Electrical - Optical Characteristics Curves

(25°C Ambient Temperature Unless Otherwise Noted)

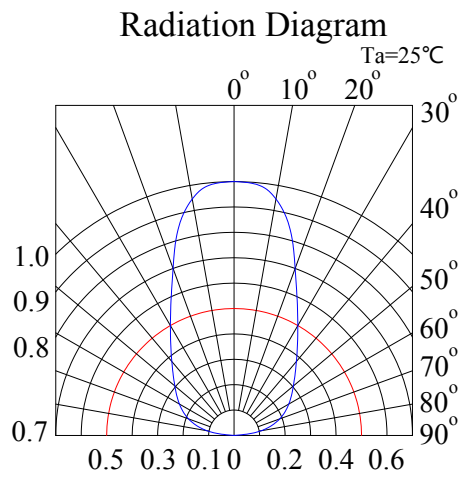
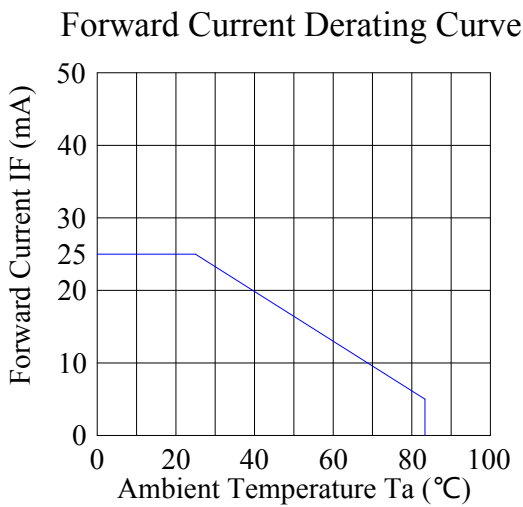
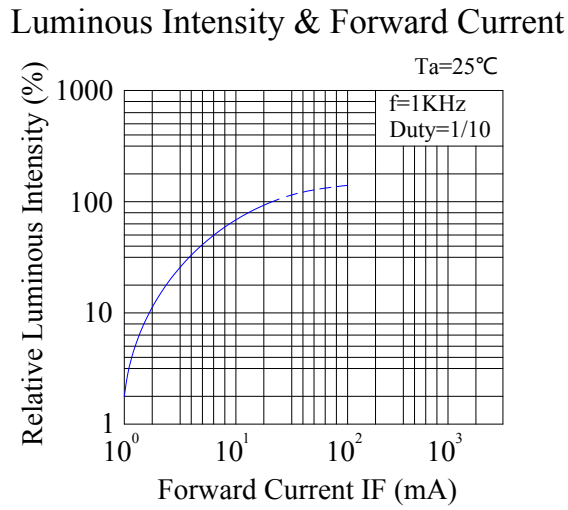
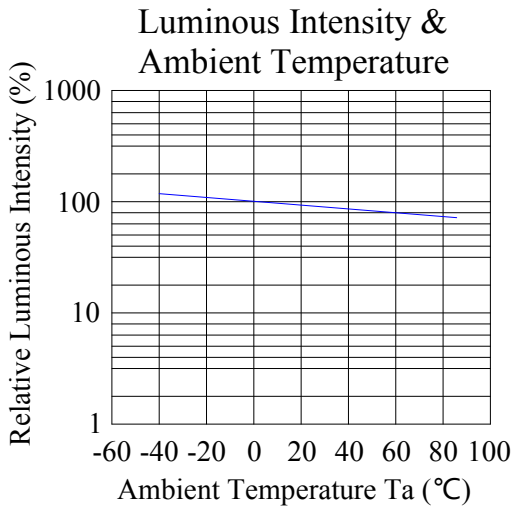
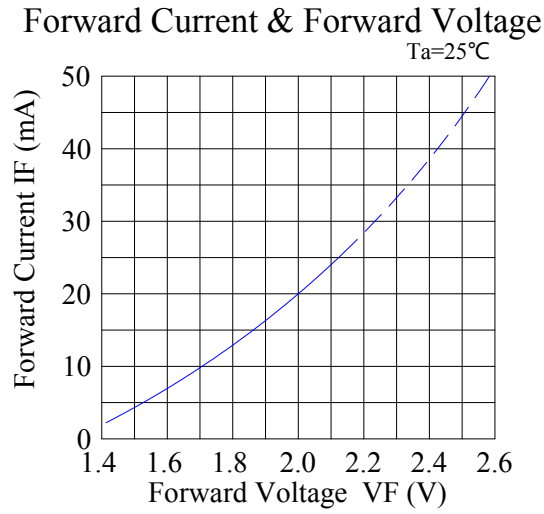
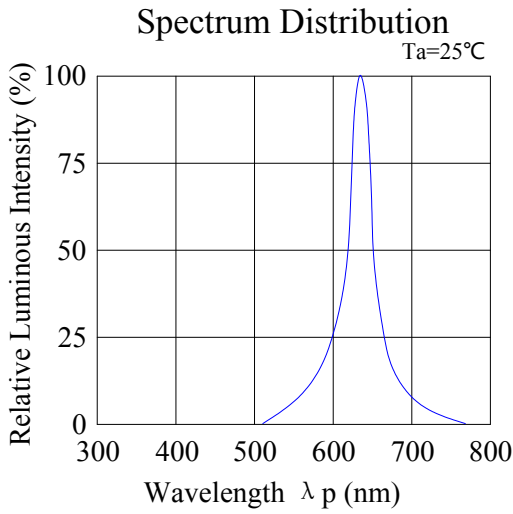

◆ Reliability Test

Classification	Test Item	Reference Standard	Test Conditions	Result
Endurance Test	Operation Life	MIL-STD-750:1026 MIL-STD-883:1005 JIS-C-7021 :B-1	Connect with a power $I_f=20\text{mA}$ T_a =Under room temperature Test time=1,000hrs	0/20
	High Temperature High Humidity Storage	MIL-STD-202:103B JIS-C-7021 :B-11	$T_a=+65^{\circ}\text{C}\pm 5^{\circ}\text{C}$ RH=90%-95% Test time=240hrs	0/20
	High Temperature Storage	MIL-STD-883:1008 JIS-C-7021 :B-10	High $T_a=85^{\circ}\text{C}\pm 5^{\circ}\text{C}$ Test time=1,000hrs	0/20
	Low Temperature Storage	JIS-C-7021 :B-12	Low $T_a=-35^{\circ}\text{C}\pm 5^{\circ}\text{C}$ Test time=1,000hrs	0/20
Environmental Test	Temperature Cycling	MIL-STD-202:107D MIL-STD-750:1051 MIL-STD-883:1010 JIS-C-7021 :A-4	$-35^{\circ}\text{C} \sim +25^{\circ}\text{C} \sim +85^{\circ}\text{C} \sim +25^{\circ}\text{C}$ 60min 20min 60min 20min Test Time=5cycle	0/20
	Thermal Shock	MIL-STD-202:107D MIL-STD-750:1051 MIL-STD-883:1011	$35^{\circ}\text{C}\pm 5^{\circ}\text{C} \sim +85^{\circ}\text{C}\pm 5^{\circ}\text{C}$ 20min 20min Test Time=10cycle	0/20
	Solder Resistance	MIL-STD-202:201A MIL-STD-750:2031 JIS-C-7021 :A-1	Preheating: $140^{\circ}\text{C}-160^{\circ}\text{C}$, within 2 minutes. Operation heating: 235°C (Max.), within 10seconds (Max.)	0/20

◆ Judgment criteria of failure for the reliability

Measuring items	Symbol	Measuring conditions	Judgment criteria for failure
Forward voltage	V_F (V)	$I_F=20\text{mA}$	Over $U_x1.2$
Reverse current	I_R (μA)	$V_R=5\text{V}$	Over U_x2
Luminous intensity	I_v (mcd)	$I_F=20\text{mA}$	Below $SX0.5$

Notes:

1. U means the upper limit of specified characteristics. S means initial value.
2. Measurement shall be taken between 2 hours and after the test pieces have been returned to normal ambient conditions after completion of each test.

◆ Soldering:

1. Manual of Soldering

The temperature of the iron tip should not be higher than 300°C (572°F) and Soldering within 3 seconds per solder-land is to be observed.

2. Reflow Soldering

Preheating: 140°C~160°C±5°C, within 2 minutes.

Operation heating: 235°C (Max.) within 10 seconds (Max)

Gradual Cooling (Avoid quenching).

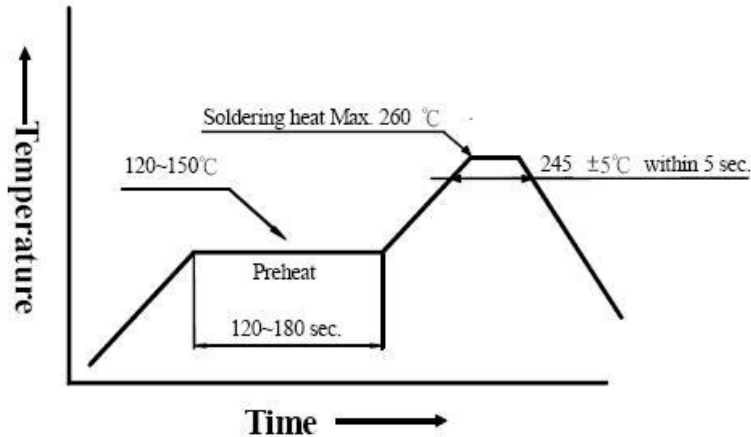

3. DIP soldering (Wave Soldering):

Preheating: 120°C~150°C, within 120~180 sec.

Operation heating: 245°C±5°C within 5 sec. 260°C (Max)

Gradual Cooling (Avoid quenching).

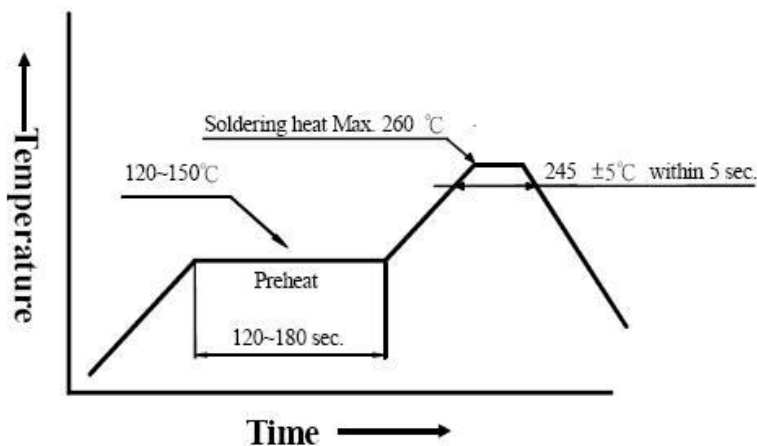

◆ Handling :

Care must be taken not to cause to the epoxy resin portion of LEDs while it is exposed to high temperature. Care must be taken not rub the epoxy resin portion of LEDs with hard or sharp article such as the sand blast and the metal hook.

◆ Notes for designing:

Care must be taken to provide the current limiting resistor in the circuit so as to drive the LEDs within the rated figures. Also, caution should be taken not to overload LEDs with instantaneous voltage at the turning ON and OFF of the circuit.

When using the pulse drive care must be taken to keep the average current within the rated figures. Also, the circuit should be designed so as to be subjected to reverse voltage when turning off the LEDs.

◆ Storage:

In order to avoid the absorption of moisture, it is recommended to solder LEDs as soon as possible after unpacking the sealed envelope.

If the envelope is still packed, to store it in the environment as following:

- 1) Temperature : 5°C-30°C (41°F), Humidity : RH 60% Max.
- 2) After this bag is opened, devices that will be applied to infrared reflow, vapor-phase reflow, or equivalent soldering process must be:
 - a) Completed within 24 hours.
 - b) Stored at less than 30% RH.
- 3) Devices require baking before mounting, if (2) a or (2) b is not met.
- 4) If baking is required, devices must be baked under below conditions: 12 hours at 60°C±3°C.

◆ Package and Label of Products:

Products are packed in one bag of 500pcs (one taping reel) and a label is attached on each bag.